

# Square Flange Captive Mounts

PART	A	B	P	F	CF	L	S	REF.
SFCM160	162	59	M20	14.5	140	170	4	
SFCM180	180	66	M20	14.5	149 - 163	192	4	
SFCM180HD	183	86	M20	14.5	146	180	5	
SFCM220	220	105	M24	17.5	180	220	6	
SFCM220HD	220	105	M24	17.5	180	220	6	

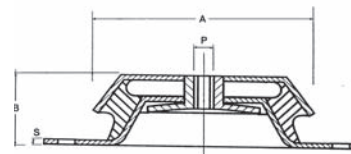
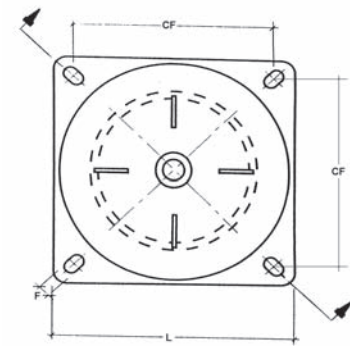
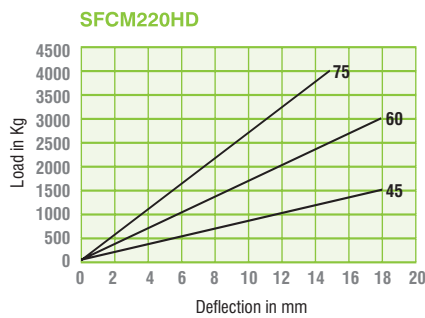
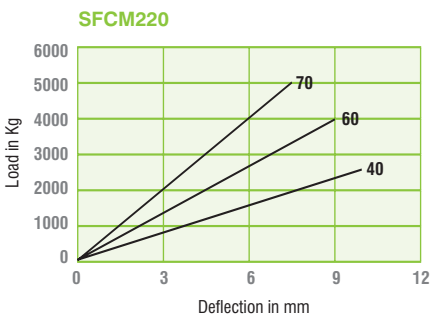
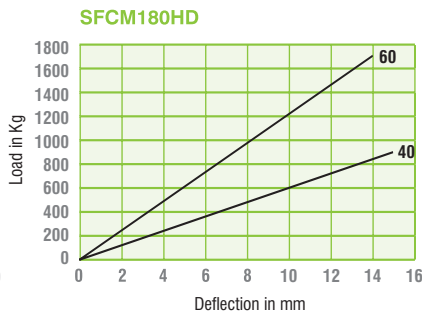
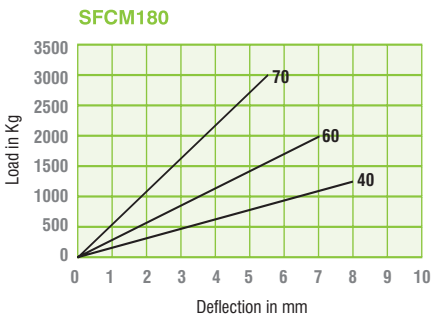
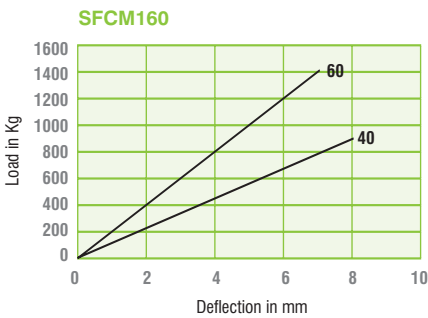

DATA SHEET SFCM 2011. Max compression load in Kg deflection in mm.

This information is for guidance only. Customers are recommended to contact us for further technical information on products and applications. We reserve the right to alter specifications or withdraw products without notice.